

en

Children's wheelchair

Model 1.135

Operating manual



CE

MEYRA®
We move people.

Contents

Introduction	4
List of models	5
Indications	5
Acceptance	5
Specifications	5
Use	6
Adjustment	6
Reinstallation	6
Life span	7
Overview	8
Brake	9
Pressure brake - user	9
Locking the brakes	9
Releasing the brakes	9
Service brake	9
Brake lever extension	10
Folding over the brake lever extension	10
Drum brake for accompanying persons	11
Function as operating brakes	11
Activating/releasing the drum brakes	11
Leg supports	12
Lower leg support	12
Footboard	12
Clothes guard	13
Clothes guard with padded arm support	13
Back support	14
Adjustable back	14
Removing the back support upholstery	14
Placing the back support upholstery	14
Back support with angle adjustment	15
Push handles	16
Stabiliser rod	17
Removing/attaching the stabiliser rod	17

Head support	18
Height adjustment / removal	18
Head support cover	18
Wheels	19
Drive wheels	19
Quick release axle	19
Hand and spoke guard	20
Support castors	21
Swinging the support castors	21
Retaining strap	22
Loading and transportation	23
Loading	23
Transport security	23
Maintenance	23
Maintenance	23
Maintenance schedule	24
Technical data	26
Tyre pressure of pneumatic tyres	26
Meaning of the labels on the wheelchair	30
Meaning of the symbols on the type plate	31
Inspection certificate	32
Notes	33
Warranty / Guarantee	34
Warrantee / Guarantee section	35
Inspection certificate for transfer	35

INTRODUCTION

We thank you for the confidence you have placed in our company by choosing a wheelchair from this series.

With all equipment and their accessories the wheelchair offers die respective adaptation to your disability.

Like any other vehicle, a wheelchair is a technical aid. It is subject to explanations, requires regular care and can cause danger when used improperly. The correct handling must therefore be learned. This operating manual is to help you get accustomed to the handling of the wheelchair as well as to prevent accidents.

Note:

Please note that the illustrated equipment variants can deviate from your model.

We have therefore also listed chapters with options that might not be applicable for your individual wheelchair.

Important information

Attention:

- ! Read and observe the following documentation belonging to the wheelchair before first operation:
 - this operating manual,
 - the safety and general handling instructions < *Mechanical and muscle powered wheelchairs* >.

Note:

Children and juveniles should read the documentation belonging to the wheelchair together with their parents respectively a supervisor or an accompanying person before first use.

Users with visual impairments can find the PDF-files of above mentioned documents on our website under:

< www.meyra.com >.

 Contact your specialist dealer when required.

Alternatively users with visual impairments can have the documentation read out by a helper.

Additional information about our products can be found on our website:

< www.meyra.com >.

 Contact your specialist dealer when required.

LIST OF MODELS

This operating manual applies to the following models:

Model 1.135

INDICATIONS

If the following indications occur we recommend the application of this mobility product:

- ☞ Walking disability resp. extremely limited walking ability as part of the basic need to move around in your own home.
- ☞ The need to be able to leave home for a short walk in fresh air or in order to reach the places, commonly in the perimeter of the home, required to fulfil basic needs.
- ☞ The ability to use the adaptive wheelchair with own personal strength must be given. Provision with an adaptive wheelchairs can be an option, when the adaptation and adjustment possibilities of standard or lightweight wheelchairs are not sufficient.

ACCEPTANCE

All products are checked for faults in the factory and packed in special boxes.

☞ Note:

However, we request that you check the vehicle for possible transport damage immediately on receipt – preferably in the presence of the carrier.

- ☞ The packaging of the wheelchair should be stored for a further transport that might become necessary.

SPECIFICATIONS

The wheelchair was developed for children and adolescents. Two frames are available:

- midi,
- maxi.

The wheelchair solely serves to transport one person in the seat and not as a hauling aid, transporter or similar.

USE

The wheelchair is applicable on level, firm surfaces and can be used as follows:

- for indoors (e.g. apartment, day care),
- outdoors (e.g. paved paths in parks),
- as a companion on tours (e.g. in a bus or train).

The wheelchair offers manifold adjustment possibilities to individual vital statistics.

The wheelchair should be adapted to your needs by a specialist dealer before the first use. The adaptation will take into account the driving experience, the physical limits of the user and the main place of use of the wheelchair.

Attention:

- ! Always have adaptation and adjustment work carried out by a specialist dealer.

ADJUSTMENT

The specialist workshop will hand out the wheelchair to you under consideration of all relevant safety instructions, ready for operation and adjusted to your needs.

Note:

- ☞ We recommend a regular control if the wheelchair adjustment in order to ensure a long-term optimal provision even with changing illness/handicap patterns of the user. Especially for children and juveniles an adjustment every 6 months is recommendable.
- ☞ We recommend regular medical exams in order to ensure safety for active participation in traffic.
- ☞ Retrospective adjustments should be carried out solely by the specialist dealer!

REINSTALLMENT

The wheelchair is suited for reinstallation. With the building block system the wheelchair can be fit to accommodate different handicaps body sizes.

LIFE SPAN

We expect an average life span of about 5 years for this product, as far as the product is applied for its designated purpose and all maintenance and service guidelines.

The life span of your product depends upon the frequency of use, the application environment and care.

The implementation of spare parts can prolong the life span of the product. As a rule spare parts are available up to 5 years after production is discontinued.

- The indicated lifespan does not constitute additional guarantee.

OVERVIEW

The overview shows, representative for all models, the most important components of the wheelchair.

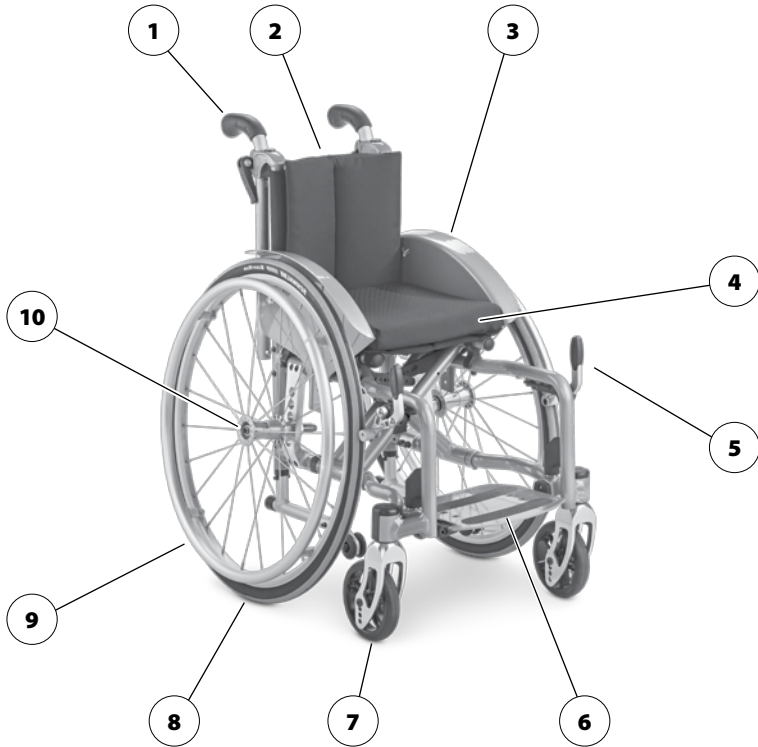

Pos. Description

- | | |
|----------------------------------|--|
| (1) Push handle | (8) Driving wheel |
| (2) Back support | (9) Handrims |
| (3) Arm support / Clothes guard | (10) Locking knob – Quick release axle |
| (4) Seat belt/seat cushion | |
| (5) Brake lever – pressure brake | |
| (6) Footboard | |
| (7) Steering wheel | |

BRAKE

By locking the brakes with the brake lever (1), the wheelchair is secured against rolling away unintentionally (parking brake).

Depending on the version, the wheelchair can be equipped with pressure brakes (2) or with drum brakes (3).

Note:

Therefore observe the *Maintenance schedule* on page 24 as well as safety and general handling instructions < *Mechanical and muscle powered wheelchairs* > chapters < *General safety information* > and < *Brakes* >.

Attention:

 Arrange an immediate repair of the brakes by your specialist workshop if the braking performance reduces.

Pressure brake - user

Locking the brakes

To secure the wheelchair against any unintentional rolling, press both brake levers forward all the way [4].

Note:

It should not be possible to push the wheelchair forward when both brakes are locked.

Releasing the brakes

Pull both brake levers back all the way [2].

Service brake

The wheelchair is braked down with help of the handrims.

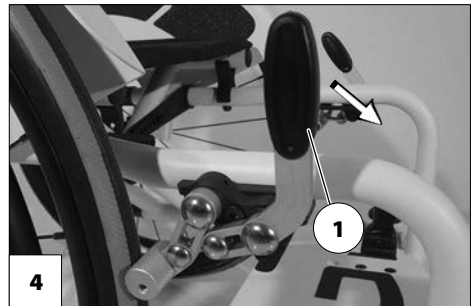
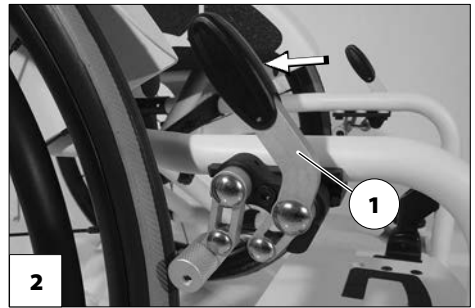

Note:

If needed use suitable gloves in order to brake down the wheelchair.

Brake lever extension

The foldaway brake levers (1) multiply the applied brake force and reduce the force you need to apply in order to lock the brakes.

Attention:

- ! Do not use the grips of the brake lever as support!
- Do not pull off the brake lever extension whilst in motion. – Accidents could result if the brake lever extension is drawn too much!

Folding over the brake lever extension

- ☞ This function is only designated for transfer into or out of the wheelchair.

To fold the brake lever extension over lift it as far as possible and then fold it forward [2] resp. lift it up and fold it down onto the brake lever.

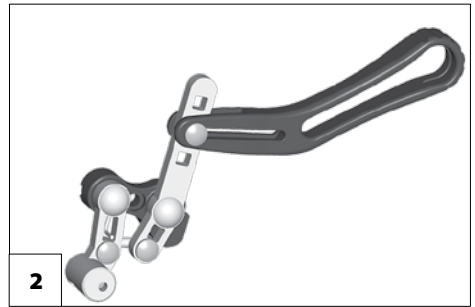
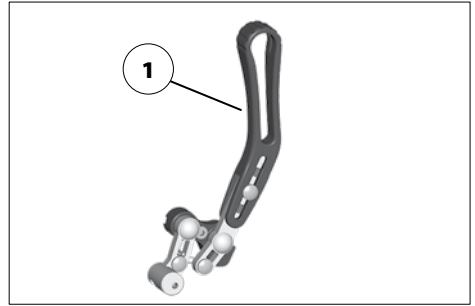

Drum brake for accompanying persons

The drum brake is activated by the accompanying person through the brake levers [1].

Function as operating brakes

Use both brake levers evenly and only lightly in order to achieve a controlled deceleration of the wheelchair.

Activating/releasing the drum brakes

For activating/releasing the drumbrakes observe the safety and general handling instructions < *Mechanical and muscle powered wheelchairs* > chapter < *Drum brake* >.



LEG SUPPORTS

Attention:

- ! Before any actions on the leg supports the wheelchair is to be secured against unintentional rolling motions.
- ☞ Therefore observe chapter *Brake* on page 9.

Lower leg support

The footboard is to be folded up for entering or exiting the wheelchair.

- ☞ Check the locking points!

- Remove both feet from the footplates.

Before starting to drive the footboard is to be lowered again.

Footboard

Folding up the footboard

To fold up the footboard, fold the loose end of the footboard as far as possible upward passed the resistance [2] resp. [5].

Folding the footboard down

To fold the footboard down, lower the loose end of the footboard as far down as possible onto the footboard bracket until it locks onto place [1] resp. [5].

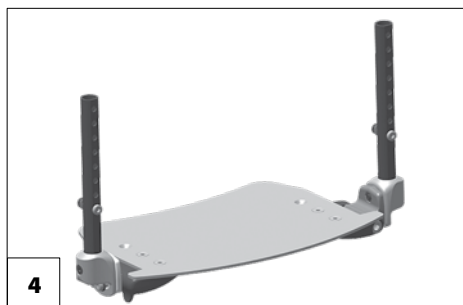
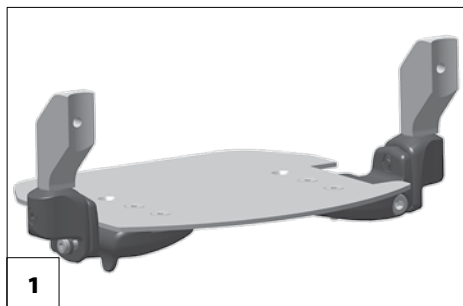

CLOTHES GUARD

Attention:

- ! Do not grab hold of the clothes guard
- [1] + [2] to lift or carry the wheelchair.
- Do not drive without the clothes guard!
- No not grab between the frame and clothes guard. – Danger of squashing!
- When being pushed in the wheelchair by the accompanying person the user has to keep his hands on the arm supports or in his lap and not at the sides between body and arm support. – Danger of squashing the fingers!

Clothes guard with padded arm support

The clothes guard with arm support [2] is height adjustable and at the same time serves as a padded arm support, clothes- and wind protector.



BACK SUPPORT

Adjustable back

The adjustable back is adjustable through a velcro strap on the spanning straps (2).

Removing the back support upholstery

For removal, first pull off the rear part of the back support upholstery (1), then fold it over to the front and pull it off of the adjustable back strap (3).

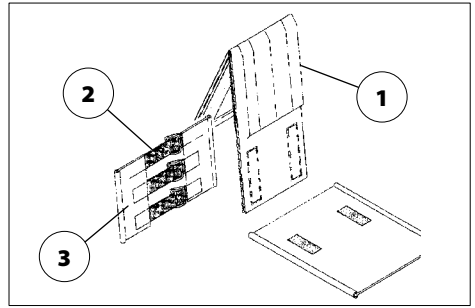

Placing the back support upholstery

For placing the back support upholstery (1), lay it centred around the upper velcro straps (2) and attach it to the adjustable back strap with the velcro fasteners (3).

☞ For a soft upper edge you should leave a little space between the upper spanning belt (2) and the folded back support upholstery (1).

☞ **Note:**

When the user leans against the back support upholstery (1) again, pay attention that:

☞ The pressure of the back must be spread evenly throughout the back support upholstery.

The extended parts of the back support are fastened to the top or bottom seat surface depending on the adjusted back support height.

Back support with angle adjustment

The back support is adjustable by max. +/- 15° in three steps of 5° each.

1. Loosen the attachment screws (1) on both sides.
 - ☞ Priorly remove the drive wheel in order to loosen the screw of the left back support tube.
2. Position the back support tubes parallel, according to the desired angle.
3. After the adjustment retighten the screws (1) on both sides.

Attention:

- ! After each adjustment of the back support the screwed connection is to be checked for secure hold!

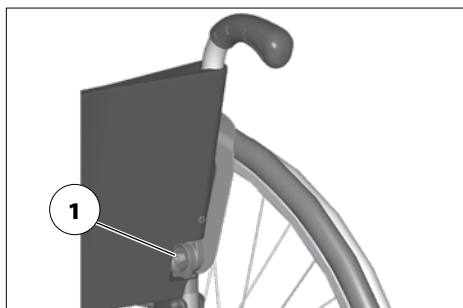

PUSH HANDLES

The height adjustable push handles are about 30 cm continuously height adjustable and secured against being pulled out [1].

Push handles with clamping device

- ✎ In doing so, hold onto the push handle that is to be adjusted with one hand.
- ✎ After each adjustment the clamping lever is to be tightened sufficiently, so that the push handle cannot be turned anymore.

Height adjustment:

Loosen the clamping levers (2) so far that the respective push handle can be adjusted into the desired position.

Angle adjustment:

Loosen the clamping levers (2) so far that the respective push handle can be turned into the desired position.

Extracting/inserting:

1. Press down the respective spring button (3) in order to extract or insert the push handles.
2. Afterwards retighten the clamping lever (2).

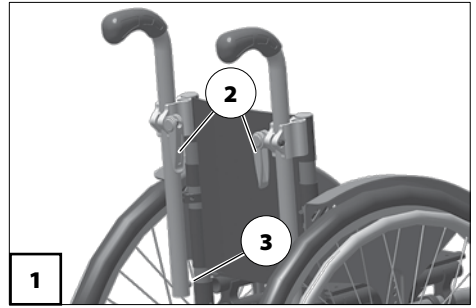

STABILISER ROD

The stabiliser rod (1) stretches the back strap at the top, serves to attach the head support and is secured against being pulled out.



 **Note:**

Only in combination with height adjustable push handles.

The stabiliser rod can be removed in order to fold the wheelchair.

Removing/attaching the stabiliser rod

1. Depress the locking buttons (2) of the quick release axle on both sides.
2. Remove [3] or insert [4] the stabiliser rod.

-  Always carry out a tensile test after inserting the axles!
-  After inserting the stabiliser rod the locking button must still protrude some millimetres from the axle. – The stabiliser rod is secured.
-  The locking bolt of the axle is to be kept clean. A functional fault may occur in the case of contamination due to sand or earth or in the event of freezing of moist cold air.

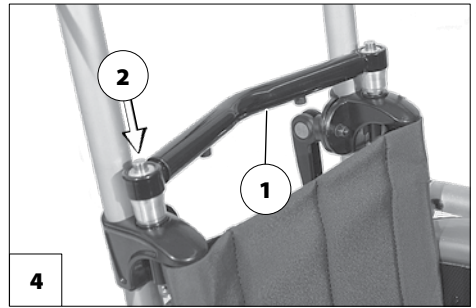

HEAD SUPPORT

The head support [1] is swivel proof, height adjustable and removable.

Height adjustment / removal

For height adjustment and removal of the head support loosen the clamping screw (2).

Attention:

- ! The maximum height adjustment is indicated by the marking!
- 🔧 The head support can also be taken off if necessary by removing the stabiliser rod [3].
- 🔧 Therefore observe chapter *Stabiliser rod* on page 17.

Head support cover

The head support cover can be removed with the zipper for washing.

- 🔧 Therefore observe the label with the washing instruction.

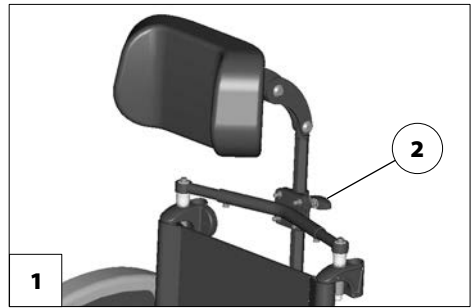



WHEELS

Drive wheels

The drive wheels are on a quick release axle [1].

Note:

The air pressure value for the tyres of the wheelchair can be read in the *Technical data* on page 26 or details on both sides of the tyre cover.



-  If the drive wheels has too much side-ward lag or the quick release axle does not engage, contact your specialist dealer immediately for repair.
-  No person may be seated in the wheelchair during assembly or removal. The wheelchair should stand on a level and firm surface. Before starting the disassembly work, support the frame to prevent the wheelchair from tipping over and secure it to prevent an unwanted movement or tipping over.

Quick release axle

The driving wheels can be removed and re-assembled without any tools.

The drive wheel can only be removed or attached when the locking button is depressed (2)..

Attention:

-  After inserting the drive wheel the locking button (2) must stick completely out of the wheel nut.
-  Herefore observe the Safety and general handling instructions < *Mechanical and muscle powered wheelchairs* > chapter < *Removable drive wheels* >.



Hand and spoke guard

The hand and spoke guard prevents injuries to the hands occurring by jamming in the turning spokes of the wheels, as well as damage to the spokes.

The spoke guard is attached to the spokes with three clips (3).

 **Note:**

Under < www.blueprince.de > further designs can be selected to exchange the hand and spoke guard.

Attention:

 Exchanging or replacing of the hand and spoke guard is to be done by the specialist dealer.



SUPPORT CASTORS

The support castors [1] serve to raise the tilting stability and can be swivelled inward underneath the seat (2).

- ☞ Depending on the version the support castors can be attached singly or as a pair.

Attention:

- ! Support castors do not provide sufficient protection against tipping over in certain situations.

- ☞ Herefore observe the Safety and general handling instructions < *Mechanical and muscle powered wheelchairs* > chapter < Support castors and wheelbase adapter >.

Swinging the support castors

Press the support castors out of the locking then swivel them inward resp. outward until the lock engages automatically [2].



RETAINING STRAP

The retaining strap [1] is screwed from the back onto the respective back support tube.

- ☞ Handling can be found in document Safety and general handling instructions < *Mechanical and muscle powered wheelchairs* > chapter < *Retaining strap* >.



LOADING AND TRANSPORTATION

Do not use the leg supports, arm supports or accessory parts in order to lift the wheelchair!

Attention:

- ! Before lifting, the wheelchair is to be secured against unintentional rolling motions!

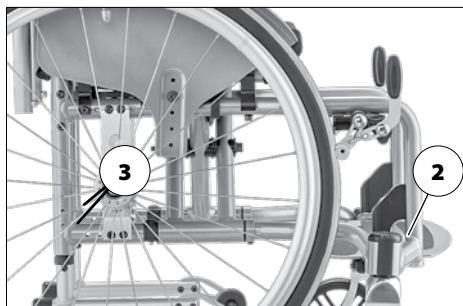

Loading

If necessary the wheelchair can be loaded with the aid of ramps or lifting platforms.

🗨️ Note:

Observe document Safety and general handling instructions < *Mechanical and muscle powered wheelchairs* > chapter < *driving on ramps and lifting platforms* >.

Transport security

The wheelchair is only to be secured through the four securing points (2) and (3).

- 🗨️ The procedure for securing the wheelchair can be read in the document Safety and general handling instructions < *Mechanical and muscle powered wheelchairs* > chapter < *Transport in motor vehicles or conveyors* >.

MAINTENANCE

An incorrect or neglected cleaning and maintenance results in a limitation of the product liability.

Maintenance

The following maintenance Instruction gives you a guide for carrying out the maintenance work.

- 🗨️ They do not give information about the actual extent of work required on the wheelchair.

Maintenance schedule

WHEN	WHAT	REMARK
Before starting out	General Test for faultless operation.	Carry out test yourself or with a helper.
Before starting out	Test brakes for faultless operation Activate brake lever to the limit.	Carry out test yourself or with a helper. The locked wheels should not be able to turn under operating conditions. If they can still turn, the brakes must be repaired by an authorised specialist workshop.
Before starting out	Check pressure brake for wear Move brake lever to the side	Carry out tests yourself or have a helper do it. If you notice any increasing slackness on the brake lever take the wheelchair to your specialist workshop immediately for repairs. – Danger of accident!
Before starting out	Check the back tubes and frame tubes for damages	Carry out the test yourself or by a helper. If deformations or cracks occur in the welding seams, contact a specialist workshop immediately for repairs. – Danger of accident!
Especially before driving in the dark (when applicable)	Check the lighting Check the light- and indicator signal equipment as well as reflectors for immaculate performance.	Carry out test yourself or with a helper.

WHEN	WHAT	REMARK
<p>Every 2 weeks (depending on distance covered)</p>	<p>Check air pressure of the tyres</p> <p>Tyre filling pressure:  View <i>Tyre pressure of pneumatic tyres</i> on page 26.</p>	<p>Carry out test yourself or with a helper. Use a tyre gauge.</p>
<p>Every 8 weeks (depending on distance covered)</p>	<p>Check tyre profile</p>	<p>Carry out visual check yourself. If the tyre profile is worn down or if the tyre is damaged, consult a specialist workshop for repairs.</p>
<p>Every 8 weeks (depending on frequency of use)</p>	<p>Check all screw connections for secure fit</p>	<p>Carry out test yourself or with a helper.</p>
<p>Every 6 months (depending on frequency of use)</p>	<p>Check</p> <ul style="list-style-type: none"> - Cleanness. - General condition. 	<p>See Care. See Repairs.</p>
<p>Manufacturer recommendation: Every 12 months (depending on frequency of use)</p>	<p>Safety inspection</p> <ul style="list-style-type: none"> - Vehicle 	<p>To be carried out by the specialist dealer.</p>

TECHNICAL DATA

All data given in the < *Technical data* > refers to the standard version.

The overall length depends on the position and size of the drive wheels.

If not noted otherwise the dimensions are determined with drive wheels of \varnothing 610 mm (24").

The widths were determined with a handrim distance of 15 mm.

Dimensional tolerance ± 1.5 cm, $\pm 2^\circ$.

Short form of wheelchair dimensions:

SH = Seat height

SW = Seat width

SD = Seat depth

BH = Back support height

RSH = Rear seat height

Calculation of the max. user weight:

Attention:

! The permissible total weight is calculated from the empty weight of the wheelchair and the maximum user-(person-) weight.

Additional weight due to subsequent additions or luggage reduce the maximum permissible passenger weight.

Example:

A driver wishes to take luggage with a weight of 5 kg. Thus, the maximum user weight is reduced by 5 kg.

Tyre pressure of pneumatic tyres

Maximum tyre pressure is printed on the tyres on each side.

Full tyre pressure – steering wheel

Standard:

2.5 - 3.5 bar = 36 - 50 psi

Full tyre pressure – drive wheel

Standard:

3.0 - 4.0 bar = 44 - 58 psi

Ultra-light running tyres:

6 bar = 87 psi

High pressure:

8 bar = 116 psi

Model: **1.135**

Type plate: at the crossbrace tube

Life span: 5 years

Dimensions: **min. / max. / manufacturer setting**

Overall length (with leg supports) (midi frame): 720 / 810 / – mm

Overall length (with leg supports) (maxi frame): 850 / 940 / – mm

Overall width (with 0° wheel camber): SW + 180 mm

Overall width (with 3° wheel camber): SW + 210 mm

Overall width (with 6° wheel camber): SW + 240 mm

Overall height: RSH + BH + 60 mm

Back support height: 25 / 40 / 30 cm

Seat width: 24 / 40 / – cm

Seat depth (midi frame): 24 / 30 / – cm

Seat depth (maxi frame): 32 / 40 / – cm

Front seat height , without cushion: 39 / 48 / – cm

Rear seat height (midi frame): 36 / 44 / – cm

Rear seat height (maxi frame): 39 / 47 / – cm

Arm support height from seat surface: 17 / 26 / 20 cm

Back support to front edge of arm support: 20 / 25 / 23 cm

Seat cushion thickness: 3 / 3 / 3 cm

Height of push-handles:

Code 502 (steplessly adjustable): 30 cm

Back support angle: 75 / 105 / 90°

Seat inclination: 0° / 10° / 4°

Foot support to seat, without seat cushion (lower shank length):

with foot board Code 55/128 (midi frame): 22 / 26.5 / – cm

with foot board Code 55/128 (maxi frame): 25 / 32 / – cm

with foot board Code 55/762 (maxi frame): 33 / 44 / – cm

Wheels

Steering wheel:

ø 100 mm:solid rubber
ø 125 mm:.....solid rubber
ø 142 mm:.....soft solid rubber

Drive wheel:

ø 560 mm (22") pneumatic tyres: (116 psi) max. 8 bar
ø 560 mm (22"):.....polyurethane foam tyres
ø 610 mm (24"):..... (116 psi) max. 8 bar
ø 610 mm (24"):.....polyurethane foam tyres

Handrim diameter:.....min. 46.5 / max. 52.0 cm

Axle:

Horizontal position:..... min. 24.5 / max. 69.5 mm

Transport dimensions

Dimensions:.....min. / max. / manufacturer setting

Folding length (midi frame): 720 / 810 / – mm

Folding length (maxi frame):850 / 940 / – mm

Length without drive wheels(midi frame):.....600 / 690 / – mm

Length without drive wheels(maxi frame):..... 720 / 810 / – mm

(Support castors are removed or swivelled underneath the seat)

Folding width:.....290 / 350 / 320 mm

Folding height (midi frame):680 / 750 / – mm

Folding height (maxi frame):.....700 / 780 / – mm

Permitted inclination/slopes

max. obstacle height (depending on the setting of the leg support height): 100 mm

Minimal turning radius:950 mm

max. permissible rising gradient:4.5° (8 %)

max. permissible falling gradient:.....4.5° (8 %)

max. permissible transverse gradient:4.5° (8 %)

static tilting safety in all directions:.....6° (10 %)

Climatic data:

Ambient temperature:..... -25 °C to +50 °C
Storage temperature:..... -40 °C to +65 °C

Weights

Permissible total weight:.....max. 85 kg
max. user weight (including additional load):.....75 kg
Max. additional loading:..... 10 kg
Empty weight:min. 10 kg

Weight of the heaviest single component:
Drive wheel: 1.7 kg
Transport weight:.....min. 6.6 kg
(without cushion, drive wheels)

MEANING OF THE LABELS ON THE WHEELCHAIR

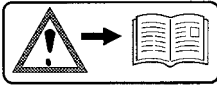

Attention!

Read the operating manuals and other provided documentation.

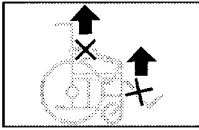

Do not lift the wheelchair at the arm supports or leg supports.

Removable parts are not suitable for carrying.

Achtung

Bremse nachstellen.

Ident.-Nr. 8390658

Attention

Readjust the brakes.

Achtung

Erhöhte Kippgefahr auf Steigung / Gefälle besonders in Verbindung mit kurzem Radstand.

Ident.-Nr. 205674400

Attention

Increased danger of tilting when on inclinations / slopes, especially in combination with short wheel base



The product is **not** approved as a seat within a motor vehicle.

Meaning of the symbols on the type plate



Manufacturer



Order number



Serial number



Production date (Year – Calendar week)



Permitted user weight



max. permissible total weight

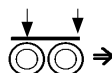

Permitted axle weights



Max. permissible rising gradient



Max. permissible falling gradient

max. ... km/h Permitted maximum speed



The product is approved as a seat within a motor vehicle



The product is **not** approved as a seat within a motor vehicle.

INSPECTION CERTIFICATE

Vehicle data:

Model:

Delivery note no.:

Serial-no.(SN):

Recommended safety inspection 1st year (at least every 12 months)

Stamp of specialist dealer:

Signature: _____

Place, date: _____

Next safety inspection in 12 months

Date: _____

Recommended safety inspection 2nd year (at least every 12 months)

Stamp of specialist dealer:

Signature: _____

Place, date: _____

Next safety inspection in 12 months

Date: _____

Recommended safety inspection 3rd year (at least every 12 months)

Stamp of specialist dealer:

Signature: _____

Place, date: _____

Next safety inspection in 12 months

Date: _____

Recommended safety inspection 4th year (at least every 12 months)

Stamp of specialist dealer:

Signature: _____

Place, date: _____

Next safety inspection in 12 months

Date: _____

Recommended safety inspection 5th year (at least every 12 months)

Stamp of specialist dealer:

Signature: _____

Place, date: _____

Next safety inspection in 12 months

Date: _____

NOTES

WARRANTY / GUARANTEE

We accept legal liability for this product within the scope of or general terms and conditions and warranty and in certain cases other verbal resp. agreed upon guarantees. For warranty and guarantee demands please contact your specialist dealer with following Warranty/Guarantee section and the there included information on model description, delivery note number with delivery date and serial number (SN).

The serial number (SN) can be read off of the type plate.

Precondition for the acceptance of liability in any case is the intended use of the product, the use of original spare parts by authorised dealers as well as maintenance and inspections in regular intervals.

Guaranty is not granted for surface damages, tyres of the wheels, damages due to loosened screws or nuts as well as worn out attachment holes due to frequent assembly work.

Furthermore, damage to the drive and electronics caused by improper cleaning using steam cleaning equipment or the deliberate or accidental flooding of the components are also excluded.

Interferences through radiation sources such as mobile phones with high transmission power, HiFi-equipment and other extreme interference radiators outside of

norm specifications cannot be declared as warranty or guarantee claims.

Attention:

- ! Failure to observe the instructions in the operating manual, improperly carried out maintenance work and, especially, technical changes and additions (add-ons) carried out without our prior consent will lead to a general loss of guarantee and product liability.

Note:

This operating manual as a part of the product is to be handed out in case of a change of owner.

We reserve the right to make technical improvements.



The product conforms with the EC Directive 93/42/EEC (MDD) for medical products.

Warranty / Guarantee section

Please fill out! Copy if necessary and send the copy to the specialist dealer.

Warranty / Guarantee

Model designation:

Delivery note no.:

SN (view type plate):

Date of delivery:

Stamp of the specialist dealer:

Inspection certificate for transfer

Vehicle data:

Serial-no.(SN):

Model:

Delivery note no.:

Stamp of specialist dealer:

Signature: _____

Place, date: _____

Next safety inspection in 12 months

Date: _____

Your specialist dealer

MEYRA GmbH



Meyra-Ring 2
D-32689 Kalletal-Kalldorf



Tel +49 5733 922 - 311
Fax +49 5733 922 - 9311



info@meyra.de

www.meyra.de
