

RGK Head Office: Units 8 A/C Ring Road, Zone 2, Burntwood Business Park, Burntwood, Staffordshire, WS7 3JQ, UK
Telephone:+44 (0) 1543 670077 - Fax:+44(0)1543 670088 - info@rgkwheelchairs.com - www.rgkwheelchairs.com

To place order: chairorders@rgkwheelchairs.com

To request quotation: quotes@rgkwheelchairs.com



Distributor Name: _____
 Contact Name: _____

Purchase Order No: _____
 Delivery Address: _____

 Postcode: _____
 Contact Name: _____
 Telephone: _____
 Email: _____

Notes/Comments:

FOR RGK OFFICE USE ONLY

| | | |
|----------------|-----|------|
| A/C No: _____ | | |
| | Who | Date |
| OK to Quote: | | |
| OK to Confirm: | | |
| Document No: | DOC | |

Net Value: € _____
 Freight: € _____
 Invoice Value: € _____
 Payment Received: € _____

- | | | |
|--|--|---|
| <input checked="" type="checkbox"/> Base Product | Mandatory Information | Information Required for Option |
| <input checked="" type="checkbox"/> Standard Configuration | <input type="checkbox"/> Option with No Extra Cost | <input type="checkbox"/> Option with Extra Cost |

INSXZ011 INTERCEPTOR
€ 3,212.00

Max User Weight 125kg

- XW010 Full CAD drawing for approval
€ 173.00
- XW011 Quick CAD drawing for approval
€ 112.00 *(Basic outline of chair within 2 working days*) *Approximate time only*

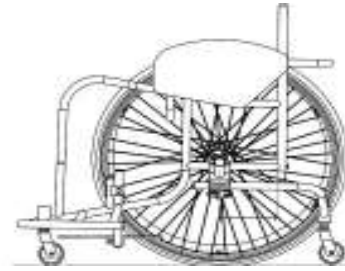

KEY FRAME MEASUREMENTS

- | | | |
|---|--|--|
| <input checked="" type="checkbox"/> XY010 | Seat width <i>(Inside of sideguards)</i> | <input type="text" value="mm"/> <i>(Max - 500mm) (Min - 250mm)</i> |
| <input checked="" type="checkbox"/> XY020 | Seat length | <input type="text" value="mm"/> <i>(Max - 500mm) (Min - 250mm)</i> |
| <input type="checkbox"/> XY030 | Extra seat length <i>(Provides additional leg support & hand grip)</i> | <input type="text" value="mm"/> |
| <input checked="" type="checkbox"/> XY050 | Front frame height | <input type="text" value="mm"/> <i>(Max - 630mm) (Min - 360mm)</i> |
| <input checked="" type="checkbox"/> XY060 | Rear frame height | <input type="text" value="mm"/> <i>(Max - 630mm) (Min - 360mm)</i> |
| <input checked="" type="checkbox"/> XY070 | Frame length | <input type="text" value="mm"/> <i>(Min XY020 + XY030 + 110mm)</i> |
| <input type="checkbox"/> XA020 | Ergonomic seat Specify length | <input type="text" value="mm"/> <i>(Standard = 120mm)</i> |

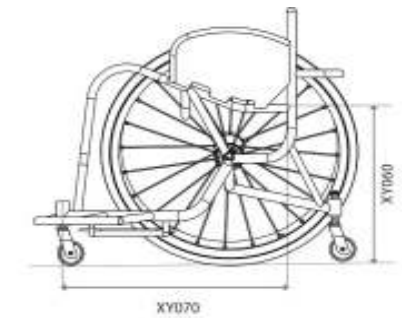
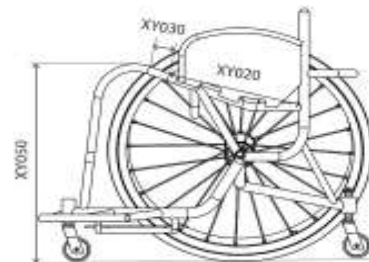

FRONT FRAME AND FOOTREST

Front Frame Options

- XY085 Seat taper design
€ 83.00



Specify width

 mm

(Optional, to provide additional leg support / positioning)

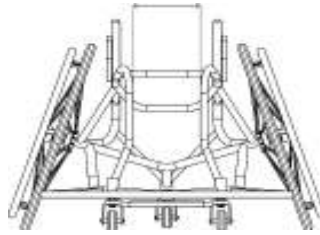

Footrest (Choose One)

Fixed Footrest

- INSB080 Fixed position footrest
€ 231.00

Height and Position



Front footrest height

 mm

(min = 35mm)

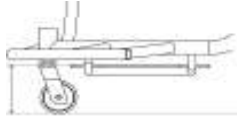



Rear footrest height

 mm

(min = 35mm)





Footrest position

(front of footplate to castor pot)

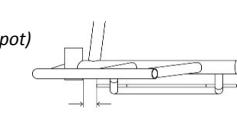
 mm

Footrest Size

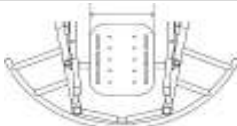
 Footrest width
(Std = 200mm)
 mm

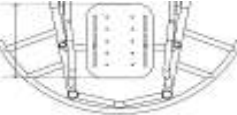

 Footrest length
(Std = 250mm)
 mm

Footrest Plate

- XB180 Aluminium footplate 2.5mm

- XB190 Carbon fibre footplate
€ 229.00

- XB100 ABS moulded foot tray
€ 135.00

Specify length (Std 330mm if not indicated)

 mm

Adjustable Footrest

- INSB130 Adjustable position footrest

Height and Position



Front footrest height

 mm

(min = 40mm)

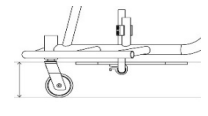



Rear footrest height

 mm

(min = 40mm)





Footrest position

(front of footplate to castor p)

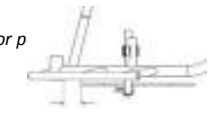
 mm

Footrest Size

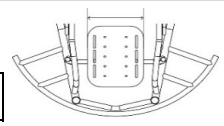
 Footrest width
(Std = 200mm)
 mm

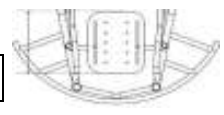

 Footrest length
(Std = 250mm)
 mm

Footrest Plate

- XB180 Aluminium footplate 5mm

- XB100 ABS moulded foot tray
€ 135.00

Specify length (Std 330mm if not indicated)

 mm

Castor Pin Width

- XY330 Castor pin width

 mm

- Optimise measurements
(Footrest plate width + 50mm)

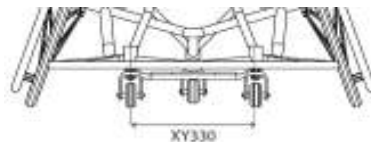

CAMBER BAR, WING AND ANTI-TIP

| Adjustable Centre of Gravity | Fixed Centre of Gravity |
|--|---|
| <p><input type="checkbox"/> INSXY560 Adjustable centre of gravity (30-150mm range)</p> <p> <input style="width: 100px;" type="text" value="mm"/></p> | <p><input type="radio"/> INSXY510 Fixed centre of gravity € 736.00</p> <p> <input style="width: 100px;" type="text" value="mm"/></p> |
| Specify Camber Angle | Specify Camber Angle |
| <p><input checked="" type="checkbox"/> XY390 Camber angle (Std = 18 degrees)</p> <p>Specify <input style="width: 100px;" type="text" value="deg"/></p> | <p><input checked="" type="checkbox"/> XY390 Camber angle (Std = 18 degrees)</p> <p>Specify <input style="width: 100px;" type="text" value="deg"/></p> |
| Wing Options (Choose one) | Wing Options (Choose one) |
| <p><input type="checkbox"/> INSXA110 Round design basketball wing (Std if no option selected)</p> <p><input type="checkbox"/> INSXA140 No wing (for Tennis and court sports)</p> | <p><input type="checkbox"/> INSXA110 Round design basketball wing (Std if no option selected)</p> <p><input type="radio"/> INSXA120 Straight sided design basketball wing € 184.00</p> <p><input type="radio"/> INSXA125 Arrow design basketball wing € 184.00</p> <p><input type="checkbox"/> INSXA140 No wing (for Tennis and court sports)</p> |
| Anti-tip options (Choose one) | Anti-tip options (Choose one) |
| <p><input type="checkbox"/> INSXJ030 Single removable anti tip</p> <p><input type="radio"/> INSXJ050 Double removable anti tip € 231.00 (With high mount joining bar)</p> <p>Specify castor pin width <input style="width: 100px;" type="text" value="mm"/></p> <p> <input type="checkbox"/> Optimise measurements (Wide as possible - std if not indicated)</p> | <p><input type="checkbox"/> INSXJ040 Single fixed anti tip</p> <p><input type="radio"/> INSXJ060 Double fixed anti tip € 231.00 (With high mount joining bar)</p> <p>Specify castor pin width <input style="width: 100px;" type="text" value="mm"/></p> <p> <input type="checkbox"/> Optimise measurements (Wide as possible - std if not indicated)</p> |

SIDEGUARDS

Sideguard Style

- | | | | | | | |
|--------------------------------|--------------------|----------|-----------------------------|-----------------------|----------|---|
| <input type="radio"/> INSXE240 | Welded sport | € 346.00 | <input type="radio"/> XE050 | Screw on carbon fibre | € 411.00 | <i>(Not recommended for basketball use)</i> |
| <input type="radio"/> XE030 | Screw on aluminium | € 184.00 | | | | |

Sideguard Measurements

- | | | | | | | | |
|--------------------------|------------------|---------------------------------|--|--------------------------|-----------------------|----------------------|--|
| <input type="checkbox"/> | Sideguard length | <input type="text" value="mm"/> | | <input type="checkbox"/> | 25mm above tyre | <i>(Follow tyre)</i> | |
| <input type="checkbox"/> | Sideguard height | <input type="text" value="mm"/> | | <input type="checkbox"/> | Individual above tyre | <i>(Follow tyre)</i> | |
| <input type="checkbox"/> | Follow tyre | | | <input type="checkbox"/> | Level with tyre | <i>(Follow tyre)</i> | |

BACKREST

Backrest Height (Choose One)

- | | | | | | | | | |
|--------------------------------|-----------------------|---------------------------------|--|-----------------------------|----------------------------|---------------------------------|------------------|--|
| <input type="checkbox"/> XY230 | Fixed height backrest | <input type="text" value="mm"/> | | <input type="radio"/> XY245 | Adjustable height backrest | € 138.00 | <i>(+/-25mm)</i> | |
| | | | | <input type="checkbox"/> | Specify height | <input type="text" value="mm"/> | | |

Ergonomics Rearward Positioning (Choose One)

- | | | | | | | | | | |
|---|------------------------------|----------------------------------|----|-----------------------------|--------------------|---------------------------------|----|--------------------------|----|
| <input checked="" type="checkbox"/> XY360 | Backrest angle | <input type="text" value="Deg"/> | | <input type="radio"/> XG100 | Ergonomic backrest | € 83.00 | | | |
| <input type="checkbox"/> | -5 | <input type="checkbox"/> | -3 | <input type="checkbox"/> | 0 | <input type="checkbox"/> | +3 | <input type="checkbox"/> | +5 |
| <input type="checkbox"/> | Individual (Max -10/+10 Deg) | | | | | | | | |
| <input type="checkbox"/> | | <input type="text" value="mm"/> | | <input type="checkbox"/> | Vertical height | <input type="text" value="mm"/> | | | |
| <input type="checkbox"/> | | | | <input type="checkbox"/> | Rearward position | <input type="text" value="mm"/> | | | |

Ergonomics Lateral positioning (Choose One)

- | | | | | | | | | | |
|-----------------------------|---------------------------------|---------|-----------------------------------|--------------------------|---------------------------------|---------------------------|---------|-----------------------------------|--|
| <input type="radio"/> XG110 | Inward taper | € 83.00 | <i>(inside of backrest posts)</i> | | <input type="radio"/> XG120 | Outward flare | € 83.00 | <i>(inside of backrest posts)</i> | |
| <input type="checkbox"/> | Specify width or per side | | | | <input type="checkbox"/> | Specify width or per side | | | |
| <input type="checkbox"/> | <input type="text" value="mm"/> | | | <input type="checkbox"/> | <input type="text" value="mm"/> | | | | |

CASTOR AND REAR WHEELS

Castor Options

- | | | | | | |
|-------------------------------------|-----------------|---|--------------------------|-----------------|--------------------------------------|
| <input checked="" type="checkbox"/> | XC160 | Sport 61mm castor (Black) | <input type="checkbox"/> | XC180 | Bones Reds bearings € 99.00 |
| <input type="checkbox"/> | INSXC230 | Extruded aluminium castor fork (Black) | <input type="checkbox"/> | INSXC200 | Sport micro fork € 125.00 (Black) |

Rear Wheel Size

- | | | | | | | | | | | | |
|--------------------------|--------------|------------|--------------------------|--------------|------------|--------------------------|--------------|------------|--------------------------|--------------|-------------|
| <input type="checkbox"/> | XY420 | 24" Wheels | <input type="checkbox"/> | XY430 | 25" Wheels | <input type="checkbox"/> | XY440 | 26" Wheels | <input type="checkbox"/> | XY450 | 700C Wheels |
|--------------------------|--------------|------------|--------------------------|--------------|------------|--------------------------|--------------|------------|--------------------------|--------------|-------------|

Rear Wheel Gap

XY460 Rear wheel gap

15 20 25

mm

Rear Wheel Options (Choose One)

- | | | | | | |
|--------------------------|--------------|--|--------------------------|--------------|--|
| <input type="checkbox"/> | XK030 | Equalizer 36/48 spoke | <input type="checkbox"/> | XK100 | Spinergy XXLX 24 spoke + caps € 765.00 |
| <input type="checkbox"/> | XK080 | Spinergy SLX 24 spoke € 727.00 | | | |

Spinergy Colour Options:

- | | | | | | | | | |
|--------------------------|--------------------------|--------------------|--------------------------|--------------------|--------------------------|--------------|--|---------------------------------|
| <input type="checkbox"/> | <input type="checkbox"/> | Black / Silver hub | <input type="checkbox"/> | White / Black hub | <input type="checkbox"/> | XK180 | Custom spoke design € 170.00 (Specify colour) | Inside: _____ Outside: _____ |
| | <input type="checkbox"/> | Red / Black hub | <input type="checkbox"/> | Blue / Black hub | | | | |
| | <input type="checkbox"/> | Yellow / Black hub | <input type="checkbox"/> | Green / Black hub | | | | |
| | <input type="checkbox"/> | Pink / Black hub | <input type="checkbox"/> | Orange / Black hub | | | | |
| | <input type="checkbox"/> | Purple / Black hub | | | | | | |

Custom Anodise Options

- | | | | | | | | | |
|--------------------------|--------------|-----------------------------|--------------------------|--------------|---------------------------|--------------------------|--------------|--|
| <input type="checkbox"/> | XK190 | Black hub € 89.00 | <input type="checkbox"/> | XK200 | Silver hub € 89.00 | <input type="checkbox"/> | XK201 | Red hub/rims € 179.00 |
| <input type="checkbox"/> | XK202 | Purple hub/rims € 179.00 | <input type="checkbox"/> | XK203 | Blue hub/rims € 179.00 | <input type="checkbox"/> | XK204 | Custom hub/rims € 236.00 Select colour: _____ |

Handrim Position

- | | | | | | |
|--------------------------|--------------|--|--------------------------|--------------|---|
| <input type="checkbox"/> | XY480 | Narrow set handrim | <input type="checkbox"/> | XY485 | Wide set handrim |
| <input type="checkbox"/> | XL090 | Remove excess mounting tabs € 106.00 (recommended for small wheel gaps) | <input type="checkbox"/> | XL080 | Super narrow set handrim € 212.00 (only with XL040 and includes XL090) |

Handrim Options

- | | | | | | |
|--------------------------|--------------|---|--------------------------|--------------|--|
| <input type="checkbox"/> | XL010 | Aluminium hard anodised 6 tab | <input type="checkbox"/> | XL040 | Titanium 6 tab € 251.00 (Not with 700C) |
| <input type="checkbox"/> | XL070 | Aluminium hard anodised 12 tab € 106.00 (24" not available) | <input type="checkbox"/> | XL050 | Stainless steel 6 tab € 138.00 |

Tyre Options

- | | | | | | | | | | | | |
|--------------------------|--------------|--|--------------------------|------|--------------------------|------|--------------------------|-----|--------------------------|--------------|---|
| <input type="checkbox"/> | XM010 | Kenda | <input type="checkbox"/> | Grey | <input type="checkbox"/> | Blue | <input type="checkbox"/> | Red | <input type="checkbox"/> | XM080 | Tufo MS3 tubeless € 87.00 (Blue only) |
| <input type="checkbox"/> | XM075 | Kenda Kaliente € 35.00 | <input type="checkbox"/> | Red | <input type="checkbox"/> | Blue | | | <input type="checkbox"/> | XM090 | Tufo WS3 tubeless € 87.00 (24" only and Blue only) |
| <input type="checkbox"/> | XM150 | IRC Exeracer Pro € 87.00 (Red only) | | | | | | | | | |

Inner Tube Valve Options

- | | | | | | |
|--------------------------|--------------|----------------------------|--------------------------|--------------|---|
| <input type="checkbox"/> | XY500 | Schraeder inner tube valve | <input type="checkbox"/> | XY490 | Presta inner tube valve (Standard if no option selected) |
|--------------------------|--------------|----------------------------|--------------------------|--------------|---|

FRAME FINISH OPTIONS

Frame & Component Finish

 XN010 Powder coated frame

 XN150 Powder coated components

| Frame | Comp. | <u>Gloss</u> |
|--------------------------|--------------------------|------------------------|
| <input type="checkbox"/> | <input type="checkbox"/> | Black gloss 103 |
| <input type="checkbox"/> | <input type="checkbox"/> | White gloss 100 |
| <input type="checkbox"/> | <input type="checkbox"/> | Grey gloss 132 |
| <input type="checkbox"/> | <input type="checkbox"/> | Cream gloss 135 |
| <input type="checkbox"/> | <input type="checkbox"/> | Red gloss 108 |
| <input type="checkbox"/> | <input type="checkbox"/> | Yellow gloss 120 |
| <input type="checkbox"/> | <input type="checkbox"/> | Forest green gloss 143 |
| <input type="checkbox"/> | <input type="checkbox"/> | Green gloss 107 |
| <input type="checkbox"/> | <input type="checkbox"/> | Dark blue gloss 151 |
| <input type="checkbox"/> | <input type="checkbox"/> | Royal blue gloss 154 |
| <input type="checkbox"/> | <input type="checkbox"/> | Blue gloss 174 |
| <input type="checkbox"/> | <input type="checkbox"/> | Duckegg blue gloss 141 |
| <input type="checkbox"/> | <input type="checkbox"/> | Pink gloss 188 |
| <input type="checkbox"/> | <input type="checkbox"/> | Orange gloss 180 |
| <input type="checkbox"/> | <input type="checkbox"/> | Purple gloss 157 |

| Frame | Comp. | <u>Matt</u> |
|--------------------------|--------------------------|---------------------|
| <input type="checkbox"/> | <input type="checkbox"/> | Black matt 105 |
| <input type="checkbox"/> | <input type="checkbox"/> | White matt 101 |
| <input type="checkbox"/> | <input type="checkbox"/> | Grey matt 131 |
| <input type="checkbox"/> | <input type="checkbox"/> | Light grey matt 133 |
| <input type="checkbox"/> | <input type="checkbox"/> | Navy blue matt 152 |

| Frame | Comp. | <u>Special</u> |
|--------------------------|--------------------------|-------------------------|
| <input type="checkbox"/> | <input type="checkbox"/> | Chrome Mirror 300 |
| <input type="checkbox"/> | <input type="checkbox"/> | Sparkle silver 170 |
| <input type="checkbox"/> | <input type="checkbox"/> | Metallic black matt 104 |
| <input type="checkbox"/> | <input type="checkbox"/> | Metallic grey matt 130 |
| <input type="checkbox"/> | <input type="checkbox"/> | Black sandpaper 201 |
| <input type="checkbox"/> | <input type="checkbox"/> | Grey sandpaper 202 |
| <input type="checkbox"/> | <input type="checkbox"/> | White sandpaper 200 |

Custom

 XN200 Custom paint colour
€ 179.00

| Frame | Comp. | Select colour/RAL: |
|--------------------------|--------------------------|--|
| <input type="checkbox"/> | <input type="checkbox"/> | <div style="border: 1px solid black; width: 100px; height: 30px;"></div> |

UPHOLSTERY

Seat Uphostery

 XP040 Seat sling adjustable tension with straps
(Not required with seat plate)
 XR040 Aluminium seat plate
€ 138.00
 mm
(Standard XY020 - 20mm)
 XR050 Carbon fibre seat plate
€ 353.00
 mm
(Standard XY020 - 20mm)

Backrest Upholstery

 XP030 Nylon backrest strap adjustable

 INSP055 Airtech sport backrest strap adjustable
€ 198.00

 XP390 Airlite backrest centre pad
€ 81.00

 XP070 Backrest upgrade to leather corners
€ 125.00
(not with XG080) (select colour)
 Black (std) Red

Backrest Accessories

 XP170 Individual backrest embroidery
€ 143.00
(Please provide .jpeg file and positioning)

| CUSHION | |
|--|---|
| Cushion foam options | |
| <input type="radio"/> XP080 Cushion foam with nylon cover € 87.00 <i>(select density and size below)</i> | <input type="checkbox"/> Soft (CMS040) <input type="checkbox"/> Medium (CMS050) <input type="checkbox"/> Hard (9lb recon) <input type="checkbox"/> 50mm <input type="checkbox"/> 75mm <input type="checkbox"/> 100mm |
| <input type="radio"/> XP340 Plastazote cushion upgrade € 81.00 <i>(Indicate max height)</i> | <input type="checkbox"/> 580mm <input type="checkbox"/> 630mm |
| Cushion cover options | |
| <input type="radio"/> XP090 Air Lite cushion cover € 67.00 <i>(Black)</i> | <input type="radio"/> XP380 Neoprene cushion cover € 93.00 |
| STRAPPING | |
| Velcro straps | Ratchet Straps |
| <input type="radio"/> XS010 100mm adjustable velcro strap € 48.00 <input type="radio"/> XS050 100mm Pro adjustable velcro strap € 125.00 <input type="radio"/> XS055 50mm Pro adjustable velcro strap € 125.00 | <input type="radio"/> XS020 Sport ratchet strap (Click strap) € 85.00 <i>(11" x 2" pad)</i> <input type="radio"/> XS025 Pelvi Loc 2DA ratchet strap € 222.00 <i>(For thighs and knees)</i> Select size: <input type="checkbox"/> Medium (8.5") <input type="checkbox"/> Large (10") <input type="radio"/> XS030 Pelvi Loc 3DA ratchet strap € 237.00 <i>(For hips)</i> Select size: <input type="checkbox"/> Small (8") <input type="checkbox"/> Medium (9") <input type="checkbox"/> Large (10") <input type="checkbox"/> Extra Large (11") <input type="radio"/> XS035 M2 ratchet strap € 142.00 <i>(For thighs and knees)</i> <input type="checkbox"/> 8" <input type="checkbox"/> 10" <input type="checkbox"/> 12" |
| Velcro strap position | |
| <input type="checkbox"/> Strap 1 position <i>(Specify type)</i> | |
| | |
| Specify strap length | Specify distance from back post |
| <input type="checkbox"/> mm | <input type="checkbox"/> mm |
| <input type="checkbox"/> Strap 2 position <i>(Specify type)</i> | |
| | |
| Specify strap length | Specify distance from back post |
| <input type="checkbox"/> mm | <input type="checkbox"/> mm |
| Ratchet strap position | |
| <input type="checkbox"/> Strap 1 position | |
| | |
| Specify distance from back | Specify distance from back |
| <input type="checkbox"/> mm | <input type="checkbox"/> mm |
| <input type="radio"/> XS040 Fixed mounting points <i>(one set per click strap)</i> € 89.00 <input type="radio"/> XS045 Clamped mounting points <i>(one set per click strap)</i> € 89.00 | <input type="checkbox"/> XS040 Calf strap mounting loops € 106.00 |
| <input type="checkbox"/> XS065 Strap location loops € 106.00 | |
| FRAME OPTIONS | |
| ACCESSORIES | |
| <input type="radio"/> XC330 Castor fork <i>(Front)</i> spare part € 125.00 <input type="radio"/> XC340 Castor fork <i>(Anti-tip)</i> spare part € 129.00 <input type="radio"/> XC345 Castor wheels incl. bearings spare part € 187.00 <i>(3 or 4 wheels depending on anti tip)</i> <input type="radio"/> XR030 Triple wheel bag € 104.00 <i>(Black)</i> <input checked="" type="checkbox"/> XR090 Tool kit | <input type="radio"/> XP130 Frame protectors full length € 94.00 <input type="radio"/> XA150 Plastic tube fitted to offensive wing € 67.00 <input type="checkbox"/> XS070 Foot strap <i>(select if required)</i> <input type="checkbox"/> XS060 Calf strap <i>(select if required)</i> <input checked="" type="checkbox"/> XP400 Back bar protector |



NOTES

A large, empty rectangular box intended for handwritten notes.

A large grid of graph paper for calculations or detailed notes.

Data Privacy - Customer Order Forms

This data privacy notice tells you about the personal data we collect from you when you purchase one or more of our products. In collecting this personal data, we are acting as a data controller and, by law, we are required to provide you with information about us, about why and how we use your data, and about the rights you have over your data.

Who are we?

We are RGK Wheelchairs. Our address is Units 8a/b/c Ring Road, Zone 2, Burntwood Business Park, Burntwood, Staffordshire, WS7 3JQ UK

You can contact us by post at the above address, by email at data.enquiries@rgklife.com or by telephone on +44 (0)1543 670077 - Any enquiries about our use of your personal data should use the contact details above.

What personal data do we collect?

When you purchase products from us, we ask you for your name, address, contact telephone number, email address. Where necessary some personal details such as; height, weight, limb measurements and any disability or disease will be required. To fulfil your order (unless under contract) we will also need your bank account details.

Why do we collect this personal data?

We will use your personal data to allow the configuration and/or customisation of your purchase, process your order and to send you your goods. We will also send you an invoice and a delivery note. If we have a question about your delivery we will use your telephone number or email address to contact you.

We process special personal data (Health) for the purposes of the provision of healthcare treatment and manufacturing of your product. The Lawful basis for processing normal personal data is Legitimate Interest this enables us to complete your order, process your payment, deliver your goods and fulfil our contract with you.

What do we do with your information?

Your information is stored in our order processing system which is based within the European Union.

We use a third-party courier companies to deliver your goods and we share with them your name, address and telephone number in order to complete the delivery.

We do not use the personal data you provide to make any automated decisions that might affect you. Your data will be shared with an external dealer (if required) and internally with our Sales Team, Customer Services, Financial Services and Quality/Warranty departments to enable fulfilment of your order and provide support services.

How long do we keep your personal data for?

Your non-financial data will be stored for the period of the warranty of the particular product purchased for a maximum of five years.

Your financial data will be stored for seven years as is required by UK Law.

Your rights over your personal data

By law, you can ask us what personal data we hold about you. You can request a copy, correct it if it is inaccurate, request we erase it, and transfer a copy to another data controller.

You can also ask us to stop using your data if you believe we are not processing it lawfully.

To submit a request by email, post or telephone, please use the contact information provided in the 'Who are we?' section.

Your right to complain

If you have a complaint about our use of your information, you can contact the Information Commissioner's Office via their website at www.ico.org/concerns or write to them at:

Information Commissioner's Office
Wycliffe House
Water Lane
Wilmslow
Cheshire
SK9 5AF