

RGK Head Office: Units 8 A/C Ring Road, Zone 2, Burntwood Business Park, Burntwood, Staffordshire, WS7 3JQ, UK
 Telephone:+44 (0) 1543 670077 - Fax:+44(0)1543 670088 - info@rgkwheelchairs.com - www.rgkwheelchairs.com

To place order: chairorders@rgkwheelchairs.com

To request quotation: quotes@rgkwheelchairs.com



Distributor Name: _____
 Contact Name: _____

Purchase Order No: _____
 Delivery Address: _____

 Postcode: _____
 Contact Name: _____
 Telephone: _____
 Email: _____

Notes/Comments:

FOR RGK OFFICE USE ONLY

A/C No: _____		
	Who	Date
OK to Quote:		
OK to Confirm:		
Document No:	DOC	

Net Value:	€ _____
Freight:	€ _____
Invoice Value:	€ _____
Payment Received:	€ _____

- Base Product
- Standard Configuration
- Mandatory Information
- Option with No Extra Cost
- Information Required for Option
- Option with Extra Cost

EXAXZ011 ELITE X
€ 6,349.00

XA600 Heat treated frame

Select frame type:

EXAXA062 Standard

EXAXA063 Standard with 25mm seatrail

EXAXA280 Heavy Duty
€ 576.00 (Bigger tube sizes and extra braces)

Max User Weight 125kg

XW010 Full CAD drawing for approval
€ 173.00

XW011 Quick CAD drawing for approval
€ 112.00 (Basic outline of chair within 2 working days*) *Approximate time only

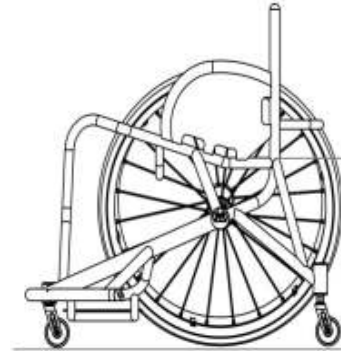

KEY FRAME MEASUREMENTS

XY010 Seat width (Inside to inside of sideguards)



XY020 Seat length

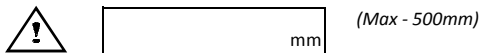

XY030 Extra seat length (Provides additional leg support & hand grip)

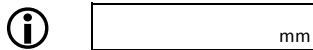

XY050 Front frame height

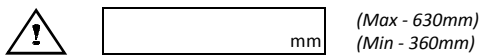

XY060 Rear frame height

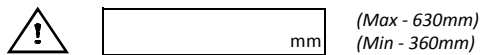

XY070 Frame length



XA020 Ergonomic seat
€ 83.00

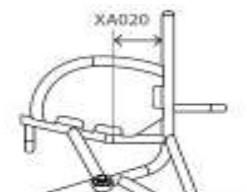
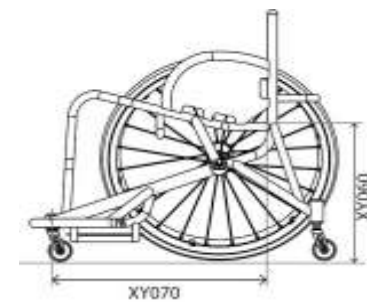
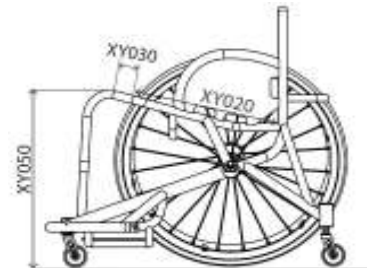
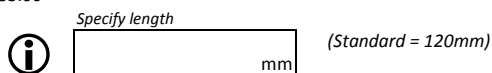

FRONT FRAME AND SEAT

Front Frame Options (Choose One)

XY080 Seat taper design

Specify taper width

mm

(Optional, to provide additional leg support / positioning)



XA130 V-seat design
€ 222.00

Specify taper width

mm

(Same measurement as XY080)

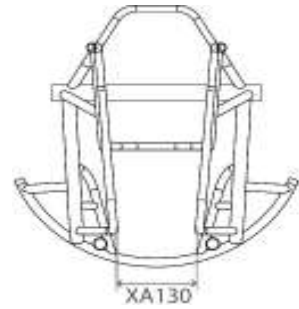

Advanced Front Frame Options

XY082 Seat taper position
€ 87.00

Specify measurement

mm

(With welded sides, dimension not smaller than sideguard length)

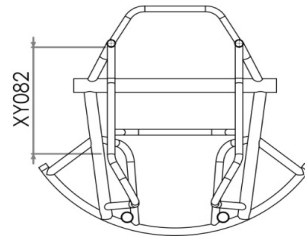

XA131 V-seat and taper design
€ 299.00

Specify inside width at front of sideguard (A)

mm

Specify taper width (B)

mm

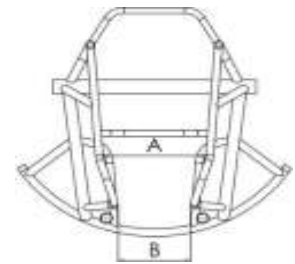

XA136 Parallel taper design
€ 87.00

Specify taper width

mm

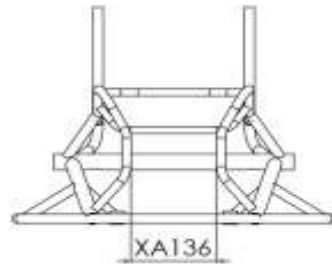

XA135 Asymmetrical taper design
€ 299.00

Specify taper width (A)

mm

Specify offset (B)
(Inside of sideguard to inside of taper width)

mm



Seat Options

XR050 Carbon fibre seat plate
€ 353.00 (riveted to frame)

Specify length of plate (Std = Seat length - 20mm)

mm

XA260 Drop seat design
€ 202.00 (only with either XR040 or 050)

Specify drop (Std = 20mm)

mm

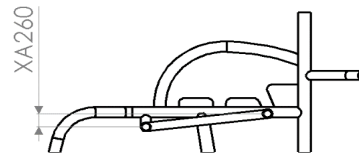

FOOTREST	
Footrest Type	
<input checked="" type="checkbox"/> EXAXB080 Fixed position footrest	<input type="checkbox"/> EXAXB145 Multi position footrest tubes € 146.00
Footrest Measurements	
<input type="checkbox"/> <div style="display: flex; align-items: center; margin-top: 5px;"> <div style="margin-right: 10px;">i</div> <div style="border: 1px solid black; padding: 2px;"> Front footrest height (min = 35mm) </div> <div style="margin-left: 10px;">mm</div> </div>	<input type="checkbox"/> <div style="display: flex; align-items: center; margin-top: 5px;"> <div style="margin-right: 10px;">i</div> <div style="border: 1px solid black; padding: 2px;"> Footrest width (Std = 200mm) </div> <div style="margin-left: 10px;">mm</div> </div>
<input type="checkbox"/> <div style="display: flex; align-items: center; margin-top: 5px;"> <div style="margin-right: 10px;">i</div> <div style="border: 1px solid black; padding: 2px;"> Rear footrest height (min = 35mm) </div> <div style="margin-left: 10px;">mm</div> </div>	<input type="checkbox"/> <div style="display: flex; align-items: center; margin-top: 5px;"> <div style="margin-right: 10px;">i</div> <div style="border: 1px solid black; padding: 2px;"> Footrest length (Std = 250mm) </div> <div style="margin-left: 10px;">mm</div> </div>
<input type="checkbox"/> <div style="display: flex; align-items: center; margin-top: 5px;"> <div style="margin-right: 10px;">i</div> <div style="border: 1px solid black; padding: 2px;"> Footrest position (front of footplate to castor pot) </div> <div style="margin-left: 10px;">mm</div> </div>	
Footrest Plate	
<input type="checkbox"/> XB190 Carbon fibre footplate € 229.00	<input type="checkbox"/> EXAXB140 Spacer kit € 18.00 (Allows for 25mm increase in height)
<input type="checkbox"/> XB100 ABS moulded foot tray € 135.00	
Specify length (Std 330mm if not indicated)	
<div style="display: flex; align-items: center;"> <div style="margin-right: 10px;">i</div> <div style="border: 1px solid black; padding: 2px;"> _____ </div> <div style="margin-left: 10px;">mm</div> </div>	
Castor Pin Width	
<input checked="" type="checkbox"/> XY330 Castor pin width	
<div style="display: flex; align-items: center; margin-top: 5px;"> <div style="margin-right: 10px;">!</div> <div style="border: 1px solid black; padding: 2px;"> _____ </div> <div style="margin-left: 10px;">mm</div> </div>	
<input type="checkbox"/> Optimise measurements	

CAMBER BAR, WING AND ANTI-TIP

Centre of Gravity and Camber Angle

EXAXY510 Fixed centre of gravity



Specify measurement

mm

(Note: dimension is taken from front of backrest to centre of axle)

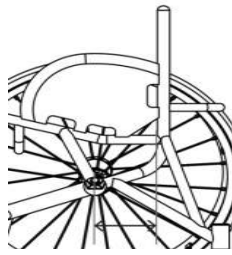

XY390 Camber angle



16 18 20 22

Wing Options (Choose one)

EXAXA110 Round design basketball wing

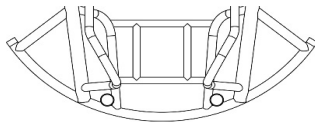

EXAXA125 Arrow design basketball wing
€ 183.00

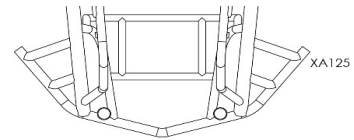

EXAXA120 Straight sided design basketball wing
€ 183.00

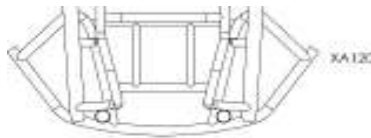

EXAXA130 Custom design basketball wing
€ 183.00

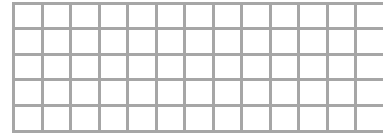

Anti-tip options (Choose one)

EXAXJ040 Single fixed anti tip

EXAXJ060 Double fixed anti tip
€ 260.00

SIDEGUARDS

Sideguard Style

- EXAXE230 Welded aluminium sport
€ 391.00
- EXAXE250 Welded CNC aluminium sport with Carbon Fibre side
€ 772.00
- XE310 High design upgrade
€ 184.00 *(Only with option ELAXE230)*

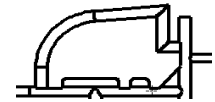

Sideguard Measurements

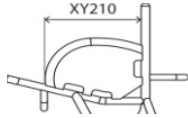
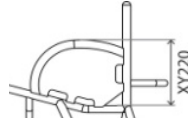
- Sideguard length

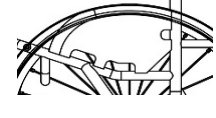
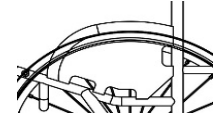
 25mm above tyre
(Follow tyre)
- Sideguard height (back)

 Individual above tyre
(Follow tyre)
- Sideguard height (front)
(optional for max height players)
 Level with tyre
(Follow tyre)
- Follow Tyre



Custom Shape

--	--

BACKREST

Backrest Height (Choose One)

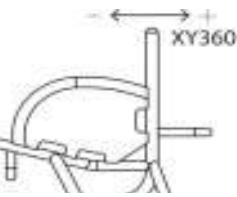

- XY230 Fixed backrest height

 Specify height

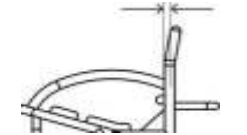
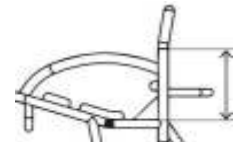

Ergonomics Rearward Positioning (Choose One)

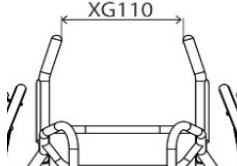
- XY360 Backrest angle

 -5 -3 0 +3 +5
 Individual
(Max -10/+10 Deg)
- XG100 Ergonomic backrest
€ 83.00
 Vertical height
 Rearward position

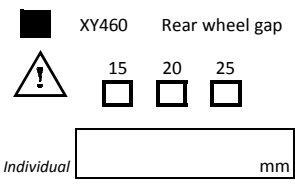
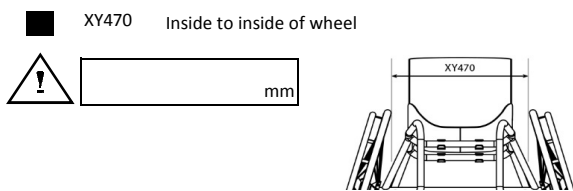

Ergonomics - Lateral positioning (Choose One)

- XG110 Inward taper
(inside of backrest posts)
 Specify width / per side

- XG120 Outward flare
(inside of backrest posts)
 Specify width / per side

CASTOR AND REAR WHEELS			
Castor Options			
<input checked="" type="checkbox"/> XC160 Sport 61mm castor (Black) <input checked="" type="checkbox"/> XC200 Sport micro fork	<input type="checkbox"/> XC181 Bones Reds bearings (All castor bearings) <input type="checkbox"/> XC182 Bones Swiss Ceramic bearings € 291.00 (All castor bearings)		
Rear Wheel Size			
<input type="checkbox"/> XY420 24" Wheels	<input type="checkbox"/> XY430 25" Wheels	<input type="checkbox"/> XY440 26" Wheels	<input type="checkbox"/> XY450 700C Wheels
Rear Wheel Gap			
<input checked="" type="checkbox"/> XY460 Rear wheel gap 	<input checked="" type="checkbox"/> XY470 Inside to inside of wheel 		
Rear Wheel Options (Choose One)			
<input type="checkbox"/> XK080 Spinergy SLX 24 spoke € 727.00 <input type="checkbox"/> XK100 Spinergy XSLX 24 spoke + Caps € 765.00	<input type="checkbox"/> XK330 Spinergy SLX R10 heavy duty 24 spoke (18 deg camber angle only) € 1,343.00 <input type="checkbox"/> XK521 Spinergy Ceramic bearing upgrade € 263.00		
Spinergy Colour Options: <input type="checkbox"/> Black / Silver hub <input type="checkbox"/> Red / Black hub <input type="checkbox"/> Yellow / Black hub <input type="checkbox"/> Pink / Black hub <input type="checkbox"/> Purple / Black hub	<input type="checkbox"/> White / Black hub <input type="checkbox"/> Blue / Black hub <input type="checkbox"/> Green / Black hub <input type="checkbox"/> Orange / Black hub <input type="checkbox"/> XK180 Custom spoke design € 170.00 (Specify colour) Inside: _____ Outside: _____		
Custom Anodise Options <input type="checkbox"/> XK190 Black Hub € 89.00 <input type="checkbox"/> XK202 Purple hub/rims € 179.00	<input type="checkbox"/> XK200 Silver hub € 89.00 <input type="checkbox"/> XK203 Blue hub/rims € 179.00 <input type="checkbox"/> XK201 Red hub/rims € 179.00 <input type="checkbox"/> XK204 Custom hub/rims € 236.00 Select colour: _____		
Handrim Position			
<input type="checkbox"/> XY480 Narrow set handrim <input type="checkbox"/> XL090 Remove excess mounting tabs € 106.00 (recommended for small wheel gaps)	<input type="checkbox"/> XY485 Wide set handrim <input type="checkbox"/> XL080 Super narrow set handrim € 212.00 (only with XL040 and includes XL090)		
Handrim Options			
<input type="checkbox"/> XL010 Aluminium hard anodised 6 tab <input type="checkbox"/> XL070 Aluminium hard anodised 12 tab € 106.00 (24" not available)	<input type="checkbox"/> XL040 Titanium 6 tab € 251.00 (Not with 700C) <input type="checkbox"/> XL050 Stainless steel 6 tab € 138.00		
Tyre Options			
<input type="checkbox"/> XM070 Kenda Kaliente <input type="checkbox"/> Red <input type="checkbox"/> Blue <input type="checkbox"/> XM150 IRC Exeracer Pro € 87.00 (Red Only)	<input type="checkbox"/> XM080 Tufo MS3 tubeless € 87.00 (Blue only) <input type="checkbox"/> XM090 Tufo WS3 tubeless € 87.00 (24" only and Blue only)		
Spare Wheel			
<input type="checkbox"/> EXAXK500 Spare wheel Spinergy € 819.00 (All inclusive + axle pin)	<input type="checkbox"/> XK520 Spare wheel Titanium / Super narrow upcharge € 142.00		
Inner Tube Valve Options			
<input type="checkbox"/> XY500 Schraeder inner tube valve 	<input type="checkbox"/> XY490 Presta inner tube valve (Standard if no option selected) 		

FINISH OPTIONS

Frame finish

XN010 Powder coated frame

Frame **Gloss**

- Black gloss 103
- White gloss 100
- Grey gloss 132
- Cream gloss 135
- Red gloss 108
- Yellow gloss 120
- Forest green gloss 143
- Green gloss 107
- Dark blue gloss 151
- Royal Blue gloss 154
- Blue gloss 174
- Duckegg blue gloss 141
- Pink gloss 188
- Orange gloss 180
- Purple gloss 157

Frame **Matt**

- Black matt 105
- White matt 101
- Grey matt 131
- Light grey matt 133
- Navy blue matt 152

Frame **Special**

- Chrome/mirror 300
- Sparkle silver 170
- Metallic black matt 104
- Metallic grey matt 130
- Black sandpaper 201
- Grey sandpaper 202
- White sandpaper 200

Custom

XN200 Custom paint colour
€ 179.00

Frame

EXAXN030 Brushed frame
€ 278.00

EXAXN050 Polished frame
€ 916.00

Accent Colour (Choose One)

Note: Accent colour includes, forks, castor caps, decals, ELITE logo and stitching. Cushion, toe strap, frame protectors and RGK logo are white.

- | | |
|---|---|
| <p><input type="checkbox"/> Black accent</p> <p><input type="checkbox"/> Red accent</p> <p><input type="checkbox"/> Purple accent</p> | <p><input type="checkbox"/> Silver accent</p> <p><input type="checkbox"/> Blue accent</p> <p><input type="radio"/> XN250 Custom
€ 179.00 <input style="width: 80px; height: 20px;" type="text" value="Select Colour:"/></p> |
|---|---|

UPHOLSTERY (N/A WITH CX SEAT)

Seat Upholstery

EXAXP040 Seat sling adjustable tension with straps
(Comes with Ti buckles) (Not required with seat plate)

Backrest Upholstery

EXAXP055 Airtech sport backrest strap adjustable
(comes with Ti buckles)

XP395 Nylon backrest centre pad

XP070 Backrest upgrade to leather corners
€ 125.00 (not with XG080) (select colour)

- Black (std) Red

Backrest Accessories

XP170 Individual backrest embroidery
€ 143.00 (Please provide .jpeg file and positioning)

CUSHION	
Cushion foam options	
<input type="radio"/> XP080 Cushion foam with nylon cover € 87.00 <i>(select density and size below)</i> <input type="checkbox"/> Soft (CMS040) <input type="checkbox"/> 50mm <input type="radio"/> XP340 Plastazote cushion upgrade € 81.00 <i>(Indicate max height)</i> <input type="checkbox"/> 580mm <input type="checkbox"/> 630mm	<input type="checkbox"/> Medium (CMS050) <input type="checkbox"/> 75mm <input type="checkbox"/> Hard (9lb recon) <input type="checkbox"/> 100mm
Cushion cover options	
<input type="radio"/> XP090 Air Lite cushion cover € 67.00 <i>(Black)</i>	<input type="radio"/> XP380 Neoprene cushion cover € 93.00
STRAPPING	
Velcro straps	Ratchet Straps
<input type="radio"/> XS050 100mm Pro adjustable velcro strap € 125.00 <input type="radio"/> XS055 50mm Pro adjustable velcro strap € 125.00 <input type="radio"/> XS057 50mm Pro adjustable velcro Knee strap € 125.00 <i>(measurement from tube to tube)</i>	<input type="radio"/> XS020 Sport ratchet strap (Click strap) € 85.00 <input type="radio"/> XS025 Pelvi Loc 2DA ratchet strap € 222.00 <i>(For thighs and knees)</i> Select size: <input type="checkbox"/> Medium (8") <input type="checkbox"/> Large (10") <input type="radio"/> XS030 Pelvi Loc 3DA ratchet strap € 237.00 <i>(For hips)</i> Select size: <input type="checkbox"/> Small (8") <input type="checkbox"/> Medium (9") <input type="checkbox"/> Large (10") <input type="checkbox"/> Extra Large (11") <input type="radio"/> XS035 M2 ratchet strap € 142.00 <i>(For thighs and knees)</i> <input type="checkbox"/> 8" <input type="checkbox"/> 10" <input type="checkbox"/> 12"
Velcro strap position	
<input type="checkbox"/> Strap 1 position <i>(Specify type)</i>	
 Specify strap length <input type="text" value=""/> mm	 Specify distance from back post <input type="text" value=""/> mm
<input type="checkbox"/> Strap 2 position <i>(Specify type)</i>	
 Specify strap length <input type="text" value=""/> mm	 Specify distance from back post <input type="text" value=""/> mm
Ratchet strap position	
<input type="checkbox"/> Strap 1 position	
 Specify distance from back <input type="text" value=""/> mm	<input type="checkbox"/> Strap 2 position
 Specify distance from back <input type="text" value=""/> mm	<input type="radio"/> XS040 Fixed mounting points <i>(one set per click strap)</i> € 89.00
FRAME OPTIONS	
<input type="radio"/> XR060 Calf strap mounting loops € 106.00	<input type="radio"/> XR065 Strap location loops € 106.00
ACCESSORIES	
<input type="radio"/> XC330 Castor fork <i>(Front)</i> spare part € 125.00 <input type="radio"/> XC340 Castor fork <i>(Anti-tip)</i> spare part € 129.00 <input type="radio"/> XC346 Castor wheels incl. Bones Reds bearings spare part € 226.00 <i>(3 or 4 wheels depending on anti tip)</i> <input type="radio"/> XR030 Triple wheel bag € 104.00 <i>(Black)</i> <input type="checkbox"/> XR090 Tool kit	<input type="radio"/> XP130 Frame protectors full length € 94.00 <input type="radio"/> XA150 Plastic tube fitted to offensive wing € 67.00 <input type="checkbox"/> XS070 Foot strap <input type="checkbox"/> XS060 Calf strap <input type="checkbox"/> XP400 Back bar protector

NOTES

Blank rectangular area for notes.

Grid area for notes.

Data Privacy - Customer Order Forms

This data privacy notice tells you about the personal data we collect from you when you purchase one or more of our products. In collecting this personal data, we are acting as a data controller and, by law, we are required to provide you with information about us, about why and how we use your data, and about the rights you have over your data.

Who are we?

We are RGK Wheelchairs. Our address is Units 8a/b/c Ring Road, Zone 2, Burntwood Business Park, Burntwood, Staffordshire, WS7 3JQ UK

You can contact us by post at the above address, by email at data.enquiries@rgklife.com or by telephone on +44 (0)1543 670077 - Any enquiries about our use of your personal data should use the contact details above.

What personal data do we collect?

When you purchase products from us, we ask you for your name, address, contact telephone number, email address. Where necessary some personal details such as; height, weight, limb measurements and any disability or disease will be required. To fulfil your order (unless under contract) we will also need your bank account details.

Why do we collect this personal data?

We will use your personal data to allow the configuration and/or customisation of your purchase, process your order and to send you your goods. We will also send you an invoice and a delivery note. If we have a question about your delivery we will use your telephone number or email address to contact you.

We process special personal data (Health) for the purposes of the provision of healthcare treatment and manufacturing of your product. The Lawful basis for processing normal personal data is Legitimate Interest this enables us to complete your order, process your payment, deliver your goods and fulfil our contract with you.

What do we do with your information?

Your information is stored in our order processing system which is based within the European Union.

We use a third-party courier companies to deliver your goods and we share with them your name, address and telephone number in order to complete the delivery.

We do not use the personal data you provide to make any automated decisions that might affect you. Your data will be shared with an external dealer (if required) and internally with our Sales Team, Customer Services, Financial Services and Quality/Warranty departments to enable fulfilment of your order and provide support services.

How long do we keep your personal data for?

Your non-financial data will be stored for the period of the warranty of the particular product purchased for a maximum of five years.

Your financial data will be stored for seven years as is required by UK Law.

Your rights over your personal data

By law, you can ask us what personal data we hold about you. You can request a copy, correct it if it is inaccurate, request we erase it, and transfer a copy to another data controller.

You can also ask us to stop using your data if you believe we are not processing it lawfully.

To submit a request by email, post or telephone, please use the contact information provided in the 'Who are we?' section.

Your right to complain

If you have a complaint about our use of your information, you can contact the Information Commissioner's Office via their website at www.ico.org/concerns or write to them at:

Information Commissioner's Office
Wycliffe House
Water Lane
Wilmslow
Cheshire
SK9 5AF